



SRV



General Description

The SRV is a DIN rail mounted module type temperature controller. Dual loop control can be performed with a single compact module. A maximum of 31 modules can be connected for 62-loop control. Power supply and communication lines are via a connector on the side, no wiring required. Distributed installation via RS-485 is possible, enabling multi-zone distributed control system in a compact size.

Features

- ☆ Multi-zone space-saving and less wiring
- ☆ Safe, and easy to use
- ☆ Heat/Cool action
- ☆ Heater/Loop break alarms
- ☆ DIN rail mounting

Space-Saving and Less Wiring

Dual loop control can be performed with a single compact module.
 Separated installation by control zones is possible. Wiring to sensors and output devices is minimized.
 Modules can be installed separately inside a control panel or a machine to reduce the physical size of the housing.

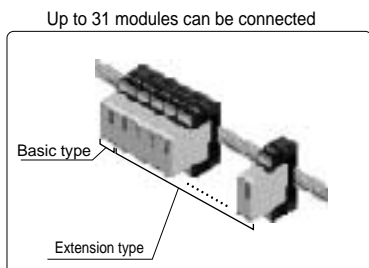
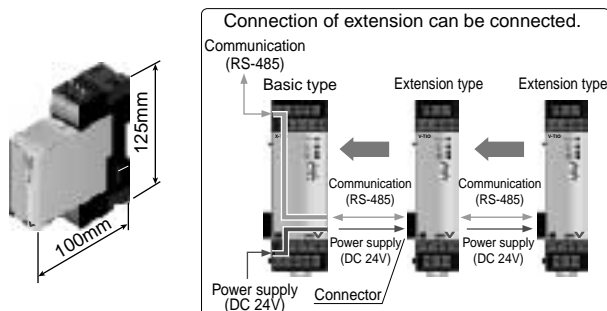

Safe, and Easy to Use

Hinged terminal cover is supplied as standard.

Interleave terminal arrangement for easy wiring.

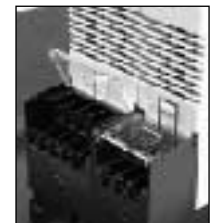

Module Configuration

Temperature Control Module (Basic Type) V-TIO-A

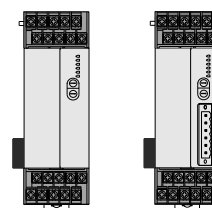

(With Digital input/output)

Temperature Control Module (Extension Type) V-TIO-B

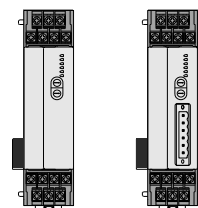

(With Digital input/output)

Heat/Cool type Temperature Control Module (Basic Type) V-TIO-C

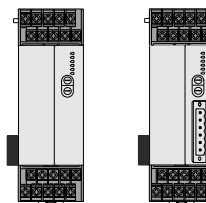

(With Digital input/output)

Heat/Cool type Temperature Control Module (Extension Type) V-TIO-D

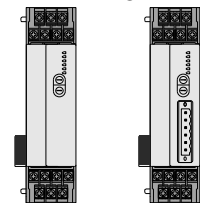

(With Digital input/output)

V-TIO-A and V-TIO-B (or V-TIO-C and V-TIO-D) have similar control functions and specifications.
 V-TIO-A and V-TIO-B can accept maximum of two inputs.
 (A single input only for V-TIO-C and V-TIO-D).

Specifications

Input

Number of inputs

- 2 points (V-TIO-A/B)
- 1 point (V-TIO-C/D)
 - 2 points type : Isolated between each channel (Only thermocouple)

Input

- a) Thermocouple, DC low voltage group
 - Thermocouple : K, J, R, S, B, E, T, N (JIS/IEC), PLII (NBS), W5Re/W26Re (ASTM)
 - Input impedance : Approx. 1M Ω
 - Influence of external resistance : Approx. 0.15 μ V/ Ω
 - Input break action : Up-scale
 - DC Low voltage : 0-100mV DC
 - Input break action : Up-scale
- b) RTD group
 - Pt100 (JIS/IEC), JPt100 (JIS)
 - Maximum 10 Ω per wire
 - Input break action : Up-scale
- c) DC High voltage, DC current group
 - DC High voltage : 0 to 5V DC, 1 to 5V DC, 0 to 10V DC
 - Input break action : Value around 0V
 - DC current : 0 to 20mA DC, 4 to 20mA DC
 - Input impedance : 250 Ω
 - Input break action : Value around 0V

Sampling Time

0.5 sec

PV Bias

-span to +span

Digital Filter

1 to 100 sec. (OFF when 0 is set.)

Performance

Measuring Accuracy

- Type : K, J, T, E, PLII
 - Less than -100°C (-148°F) : $\pm 2.0^{\circ}\text{C}$ ($\pm 3.6^{\circ}\text{F}$)
 - 100 to 333°C (-148 to 633.2°F) : $\pm 1.0^{\circ}\text{C}$ ($\pm 1.8^{\circ}\text{F}$)
 - More than 334°C (633.2°F) : $\pm (0.3\%$ of Reading + 1 digit)
- Type : N, S, R, W5Re/W26Re
 - Less than 667°C (1232.6°F) : $\pm 2.0^{\circ}\text{C}$ ($\pm 3.6^{\circ}\text{F}$)
 - More than 667°C (1232.6°F) : $\pm (0.3\%$ of Reading + 1 digit)
- Type : B
 - Less than 400°C (752°F) : $\pm 70.0^{\circ}\text{C}$ ($\pm 126^{\circ}\text{F}$)
 - 400 to 666°C (752 to 1232.6°F) : $\pm 2.0^{\circ}\text{C}$ (3.6°F)
 - More than 667°C (1232.6°F) : $\pm (0.3\%$ of Reading + 1 digit)
- Cold junction temperature compensation error
 - $\pm 1.0^{\circ}\text{C}$ (1.8°F) [at 23°C $\pm 2^{\circ}\text{C}$ (73.4°F $\pm 3.6^{\circ}\text{F}$)]
 - Within $\pm 1.5^{\circ}\text{C}$ ($\pm 2.7^{\circ}\text{F}$) [Between -10 and 50°C (14 and 122°F)]
- b) RTD
 - Less than 266°C (510.8°F) : $\pm 0.8^{\circ}\text{C}$ ($\pm 1.4^{\circ}\text{F}$)
 - More than 267°C (512.6°F) : $\pm (0.3\%$ of Reading + 1 digit)
- c) DC voltage and DC current
 - $\pm 0.3\%$ of span

Insulation Resistance

More than 20M Ω (500V DC) between each isolation block

Dielectric Strength

More than 600V AC for one minute between each isolation block

Control

Control Method

- Brilliant PID control (with autotuning)
 - Direct action/Reverse action is selectable.
 - ON/OFF action is selectable.
- Heat/Cool Brilliant PID control (with autotuning)
 - Air cooling/Water cooling is selectable.

Major Setting Range

- Set value : Same as input range.
- Proportional band : 0 to input span (Temperature)
0.0 to 100.0% of input span (Voltage, Current)
(ON/OFF action when P=0)
- Cool side proportional band : 0 to input span (Temperature)
0.0 to 100.0% of input span (Voltage, Current)
- Integral time : 1 to 3600 sec.
- Derivative time : 0 to 3600 sec.
- Control response : Slow, Medium, Fast

- Output limiter : -5.0 to +105.0% (High/Low individual setting)
- Proportional cycle time : 1 to 100 sec. (Heat/Cool individual setting)
- Other setting : Auto/Manual selectable

Control Output

- Relay output : Form A contact, 250V AC 3A (resistive load)
- Voltage pulse output : 0/12V DC
(Load resistance : More than 600 Ω)
0 to 20mA, 4 to 20mA DC
(Load resistance : Less than 600 Ω)
- Current output : 0 to 5V, 0 to 10V, 1 to 5V DC
(Load resistance : More than 1k Ω)
- Continuous voltage output : 0 to 5V, 0 to 10V, 1 to 5V DC
(Load resistance : More than 1k Ω)

Alarms

Event (Alarm) Output

- a) Number of alarms : Up to 2 points / ch
- b) Type : Deviation High, Low, High/Low, Band, Process High, Low
 - Hold action is available except for Band.
 - Alarm is interlock and delay timer is available.
- c) Setting range : Deviation alarm : -span to +span
Deviation High/Low, Band : 0 to span
Process alarm : Same as input range
- d) Differential gap : 0 to input span
- e) Output : Communication data or event output (Option)

Loop break alarm (LBA)

- a) Number of alarms : 2 points (1 point/ch)
- b) LBA time setting : 0 to 7200 sec. (LBA is OFF when 0 is set)
- c) LBA deadband : 0 to input span
- d) Output : Communication data or event output (Option)

Heater Break Alarm (HBA)

- a) Number of alarms : 2 points (1 point/ch)
- b) CT type : CTL-6-P-N (30A), CTL-12-S56-10L-N (100A)
(Specify when ordering)
- c) Display range : 0.0 to 100.0A
 - Heater break alarm function is OFF when 0.0 setting.
- d) Accuracy : $\pm 5\%$ of input value or $\pm 2\text{A}$ (whichever is larger)
- e) Output : Communication data or event output (Option)

Communications

- a) Communication method : Based on RS-485 (2-wire)
- b) Communication speed : 2400, 9600, 19200, 38400 BPS
- c) Protocol : ANSI X3.28(1976) 2.5 A4
MODBUS
- d) Bit format
 - Start bit : 1
 - Data bit : 7 or 8 • For MODBUS 8 bit only
 - Parity bit : Without, Odd or Even
 - Stop bit : 1
- e) Communication code : ASCII(JIS) 7-bit code
- f) Maximum connection : 31 (Address can be set from 0 to 99.)

Event Inputs

(Optional)

- Number of Inputs : 1 point

Event Input Type

- a) RUN/STOP switching (OPEN : STOP, CLOSE : RUN)
- b) Alarm interlock release (CLOSE : Interlock release)

Input Rating

- Non-voltage contact input (Source type)
- OPEN : 500k Ω or more, CLOSE : 10 Ω or less
- Rating voltage : 24VDC, Rating current : Approx. 6mA

Event Outputs

(Optional)

- Number of Inputs : 2 points

Event Output Type

- Temperature alarm output, Heater break alarm output, Control loop break alarm output, Burnout output, Temperature rise completion

Output Rating

- Relay contact output, Form A contact, 250V AC 1A (resistive load)

Specifications

General Specifications

Supply Voltage

21.6 to 26.4V DC (Ripple rate 10% p-p or less) [Rating : 24V DC]

Power Consumption

V-TIO-A/B/C/D, With event input/output : Maximum 120mA
 V-TIO-A/B/C/D, Without event input/output : Maximum 90mA

Power Failure Effect

A power failure of 20 msec or less will not affect the control action.

Operating Environments

-10 to 50°C [14 to 122°F] , 5 to 95% RH (No dew condensation)
 • Absolute humidity : MAX.W.C 29g/m³ dry air at 101.3kPa
 Free from corrosive gas, flammable gas and dust.

Memory Backup:

Backed up by non-volatile memory (EEPROM)
 Data retaining period : Approx. 10 years.
 Number of writing : Approx. 1,000,000 times

- Depending on storage and operating conditions.

Net Weight

V-TIO-A/C, With event input/output : 210g
 V-TIO-A/C, Without event input/output : 180g
 V-TIO-B/D, With event input/output : 200g
 V-TIO-B/D, Without event input/output : 170g

External Dimensions

See external dimensions.

Other Conditions

Free from external noise, vibration, shock and exposure to direct sunlight

Compliance with Standards

- CE Mark
- UL Recognized
- CSA Certified
- C-Tick Mark



System Configuration

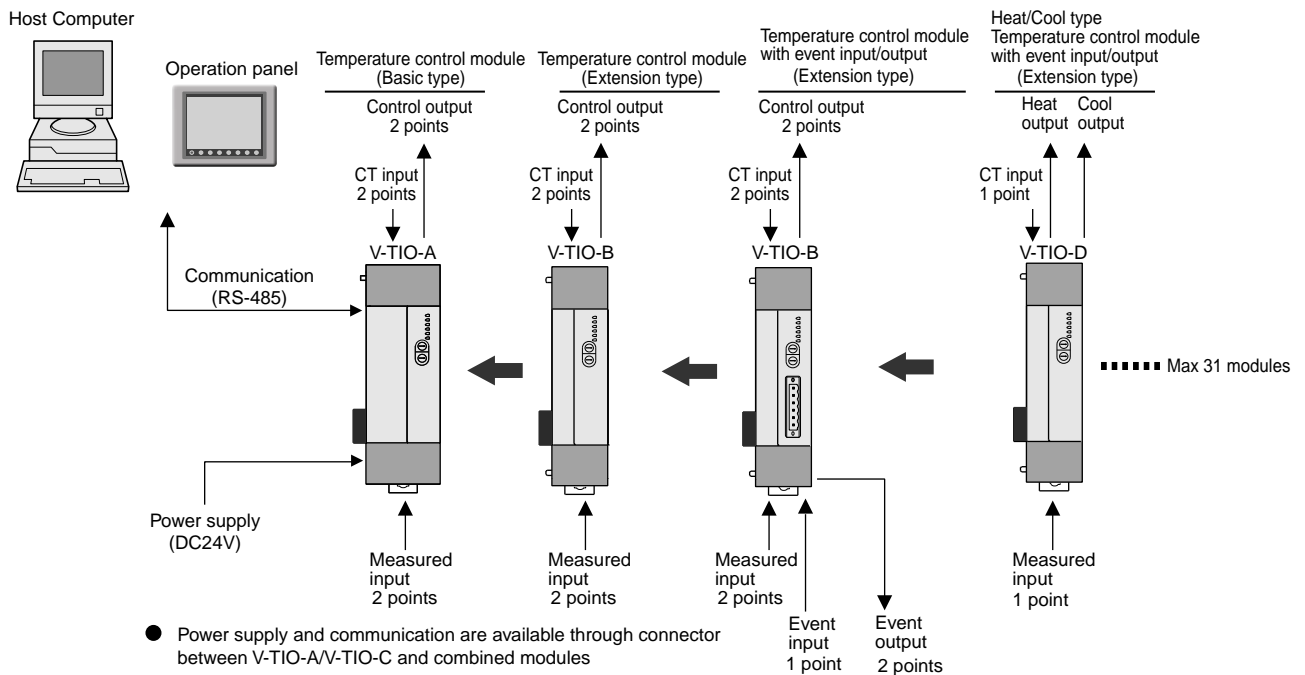

Example of distributed installation

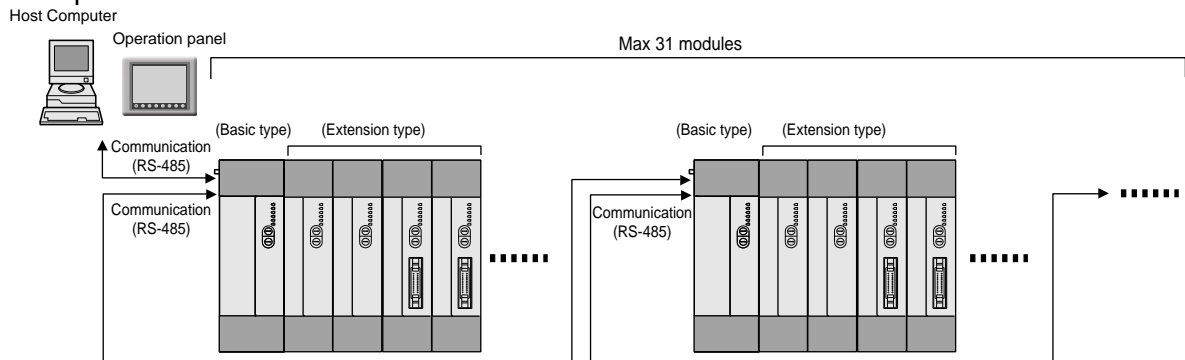

Model and Suffix Code

● Temperature Control Module

Specifications	Model and Suffix Code									
Model	V-TIO -□-□ □□□-□ □ * □ □□-□□-□-□									
Type	Basic type	Extension type	A	B						
Control method	PID control with AT (reverse action) PID control with AT (direct action)		F	D						
Measured input	See Range and Input Code Table (Common to CH1 and CH2)		□□□							
Control output 1 (CH1)	Relay output									
	Voltage pulse									
	DC voltage : 0 to 5V									
	DC voltage : 0 to 10V									
	DC voltage : 1 to 5V									
Control output 2 (CH2)	DC current : 0 to 20mA									
	DC current : 4 to 20mA									
	See control output 1 code									
Event input (DI)	No event input RUN/STOP Alarm interlock release							N		
Event output (DO1)	No event output See event output code table							1		
								2		
Event output (DO2)	No event output See event output code table								NN	
									□□	
CT type *1	CTL-6-P-N (0 to 30A) CTL-12-S56-10L-N (0 to 100A)									P
Digital communications	RS-485 (RKC standard/ANSI) RS-485 (MODBUS)									S
										5
										6

*1 Please specify "P" for CT type selection when control output is DC voltage or DC current. HBA does not operate with DC voltage or DC current outputs.

● Temperature Control Module (Heat/Cool control type)

Specifications	Model and Suffix Code									
Model	V-TIO -□-□ □□□-□ □ * □ □□-□□-□-□									
Type	Basic type	Extension type	C	D						
Control method	Heat/Cool PID control with AT (water cooling) Heat/Cool PID control with AT (air cooling)		W	A						
Measured input	See Range and Input Code Table		□□□							
Heat output	Relay output									
	Voltage pulse									
	DC voltage : 0 to 5V									
	DC voltage : 0 to 10V									
	DC voltage : 1 to 5V									
Cool output	DC current : 0 to 20mA									
	DC current : 4 to 20mA									
	See heat output code									
Event input (DI)	No event input RUN/STOP Alarm interlock release							N		
Event output (DO1)	No event output See event output code table							1		
								2		
Event output (DO2)	No event output See event output code table								NN	
									□□	
CT type *1	CTL-6-P-N (0 to 30A) CTL-12-S56-10L-N (0 to 100A)									P
Digital communications	RS-485 (RKC standard/ANSI) RS-485 (MODBUS)									S
										5
										6

*1 Please specify "P" for CT type for control output type is continuous voltage or current output, although Heater break alarm available with those types of output.

Model and Suffix Code

Range and Input Code Table

Thermocouple and Low voltage group (Field-programmable)

Input	Code	Range
K	K 02	0 - 400°C
	K 04	0 - 800°C
	K 16	-200 - 1372°C
	K 09	0.0 - 400.0°C
	K 35	-200.0 - 400.0°C
	K B9	32 - 752°F
	K B8	32 - 1472°F
	K B7	-328 - 2501°C
	K C2	32.0 - 752.0°C
	K C1	-328.0 - 752.0°C
J	J 02	0 - 400°C
	J 04	0 - 800°C
	J 15	-200 - 1200°C
	J 09	0.0 - 400.0°C
	J 27	-200.0 - 400.0°C
	J C2	32 - 752°F
	J C1	32 - 1472°F
	J B9	-328 - 2192°F
	J C4	32.0 - 752.0°F
	J C3	-328.0 - 752.0°F
R	R 06	0 - 1768°C
	R A6	32 - 3214°F
S	S 05	0 - 1768°C
	S A6	32 - 3214°F

Input	Code	Range
B	B 03	0 - 1800°C
	B B1	32 - 3272°F
E	E 01	0 - 800°C
	E 02	0 - 1000°C
	E A8	32 - 1472°F
N	E A7	32 - 1832°F
	N 02	0 - 1300°C
2	N A6	32 - 2372°F
	T 08	0 - 400°C
	T 09	0 - 200°C
	T 16	-200 - 400°C
	T 06	0.0 - 400.0°C
	T 19	-200.0 - 400.0°C
	T B9	32 - 752°F
	T C1	32 - 392°F
	T B8	-328 - 752°F
	T C3	32.0 - 752.0°F
W5Re	T C2	-328.0 - 752.0°C
	W 03	0 - 2300°C
W26Re	W A9	32 - 4172°F
	A 02	0 - 1390°C
PL II	A A2	32 - 2534°F
	0-100mVDC	2 01 Programmable

RTD group (Field-programmable)

Input	Code	Range
Pt100	D 17	0 - 400°C
	D 33	0 - 850°C
	D 16	0.0 - 400.0°C
	D 28	-200.0 - 400.0°C
	D C5	32 - 752°F
	D C4	32 - 1562°F
JPT100	D C7	32.0 - 752.0°F
	D C6	-328.0 - 752.0°F
	P 17	0 - 400°C
	P 23	0 - 600°C
	P 16	0.0 - 400.0°C
	P 28	-200.0 - 400.0°C

Voltage and Current group (Field-programmable)

Input	Code	Range
0-5V DC	4 01	Programmable
0-10V DC	5 01	
1-5V DC	6 01	
0-20mA DC	7 01	
4-20mA DC	8 01	

Event output Code Table

CH1 Event type

Code	Type
1A	CH1 Deviation High
1B	CH1 Deviation Low
1C	CH1 Deviation High/Low
1D	CH1 Band Alarm
1E	CH1 Deviation High with Hold
1F	CH1 Deviation Low with Hold
1G	CH1 Deviation High/Low with Hold
1H	CH1 Process High
1J	CH1 Process Low
1K	CH1 Process High with Hold
1L	CH1 Process Low with Hold
1Q	CH1 Deviation High with Re-Hold
1R	CH1 Deviation Low with Re-Hold
1T	CH1 Deviation High/Low with Re-Hold
1P	CH1 Heater break alarm ²
11	CH1 Control Loop Break Alarm ³
12	CH1 Burnout Alarm
13	CH1 Temperature rise completion

CH2 Event type

1 V-TIO-A/B only

Code	Type
2A	CH2 Deviation High
2B	CH2 Deviation Low
2C	CH2 Deviation High/Low
2D	CH2 Band Alarm
2E	CH2 Deviation High with Hold
2F	CH2 Deviation Low with Hold
2G	CH2 Deviation High/Low with Hold
2H	CH2 Process High
2J	CH2 Process Low
2K	CH2 Process High with Hold
2L	CH2 Process Low with Hold
2Q	CH2 Deviation High with Re-Hold
2R	CH2 Deviation Low with Re-Hold
2T	CH2 Deviation High/Low with Re-Hold
2P	CH2 Heater break alarm ²
21	CH2 Control Loop Break Alarm
22	CH2 Burnout Alarm
23	CH2 Temperature rise completion

¹ For heat/cool control, use table 1 to select event type.

² A current transformer (sold separately, See Accessory) is required to use Heater Break Alarm. HBA can operate with relay or voltage pulse output only.

³ Control Loop Break Alarm is not available with heat/cool PID control type.

Accessories

Connector (plug) for event input/output

Front screw type : SRVP-01

(An equivalent product : FRONT-MSTB 2,5/6-STF-5,08, PHOENIX CONTACT)

Side screw type : SRVP-02

(An equivalent product : MSTB 2,5/6-STF-5,08, PHOENIX CONTACT)

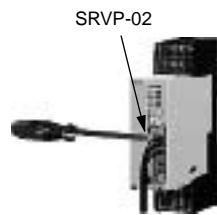
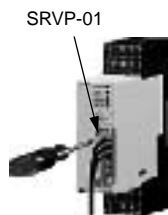

Current transformer for heater break alarm

CTL-6-P-N : 0 to 30A

CTL-12-S56-10L-N : 0 to 100A

Module type Digital Temperature Controller SRV

External Dimensions and Rear Terminals

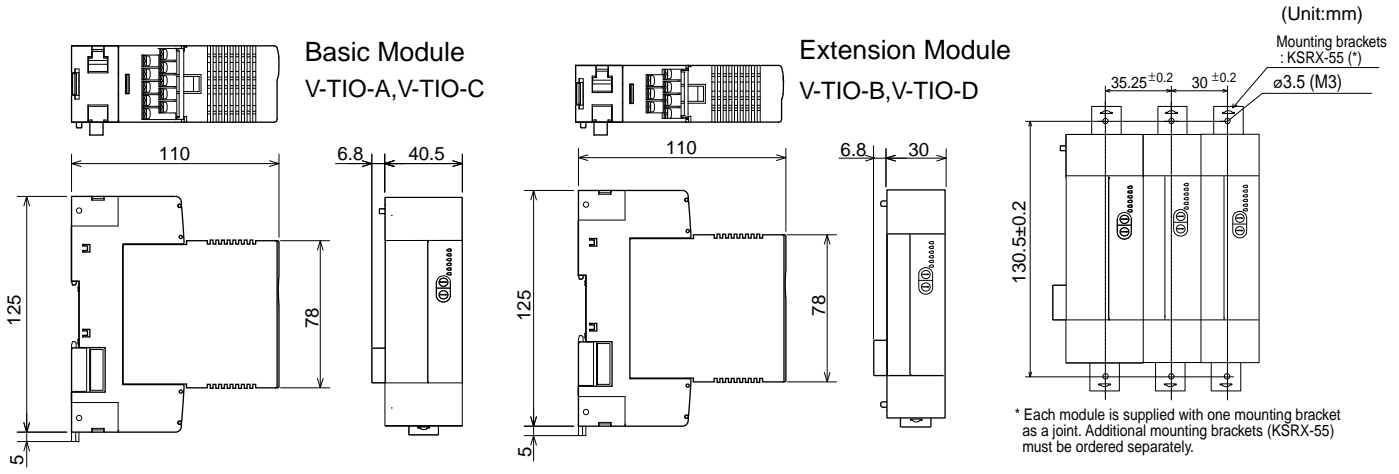

Basic Module
V-TIO-A, V-TIO-C

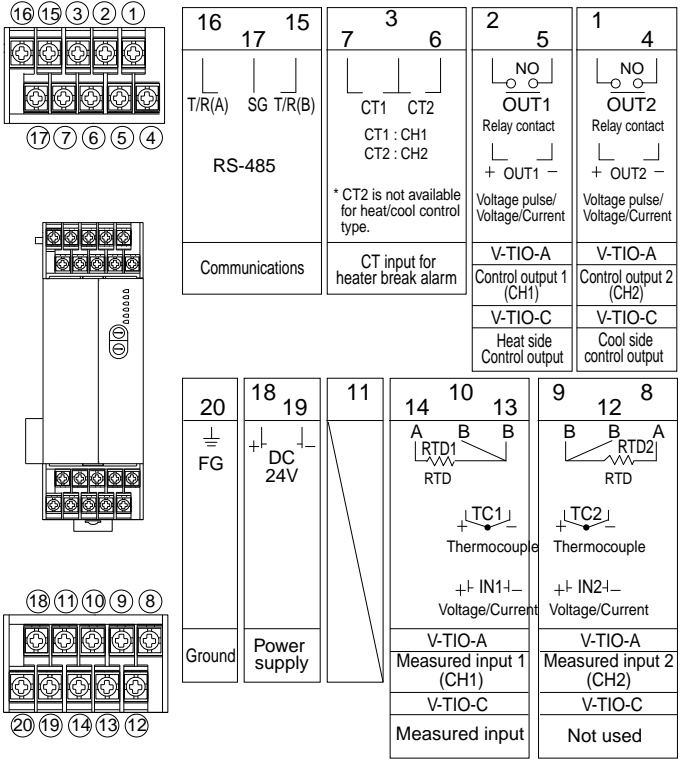

Extension Module
V-TIO-B, V-TIO-D

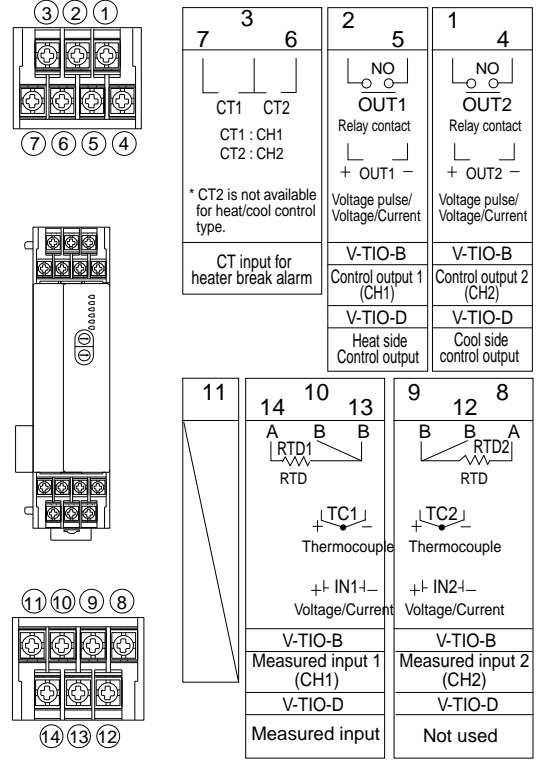

Connector (Event input/output)
V-TIO-A, V-TIO-B
V-TIO-C, V-TIO-D

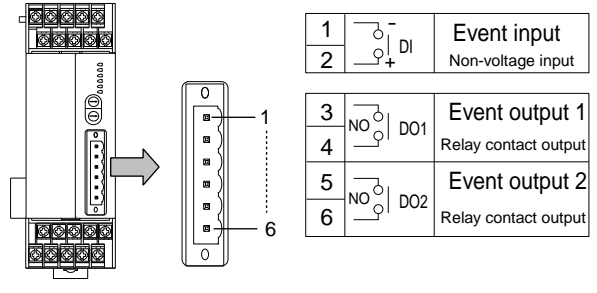

(Example: when a connector SRVP-01 is used with a module with digital input/digital output functions).

